

# OD2000-45

## Natural Gas & Propane Outdoor Gas Fireplace

### Installation and Operating Instructions

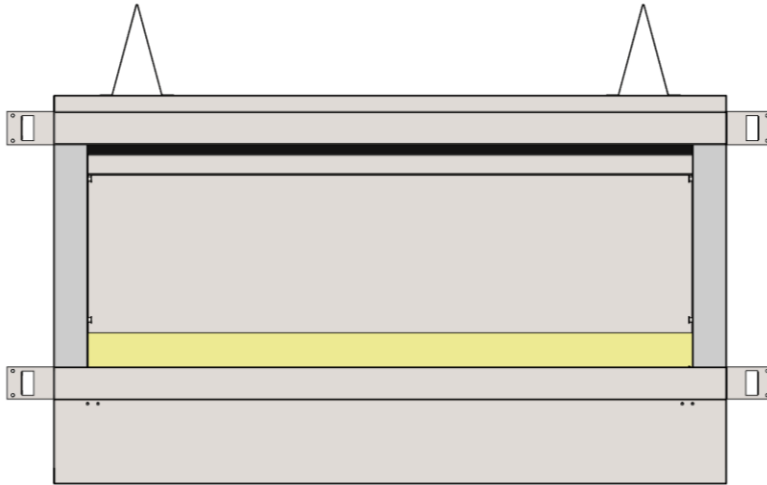

CERT # LC773211

**WARNING:** If the information in this manual is not followed exactly, a fire or explosion may result causing property damage, personal injury, or loss of life.



#### For your safety

Do not store or use gasoline or other flammable vapors and liquids in the vicinity of this or any other appliance.



#### **DANGER: IF YOU SMELL GAS**

- Shut off gas to the appliance. Extinguish any open flame. If the odor continues, keep away from the appliance and immediately call your gas supplier or your fire department.

 <b>WARNING</b>	<b>CARBON MONOXIDE HAZARD</b> <b>This appliance can produce carbon monoxide which has no odor.</b> <b>Using it in an enclosed space can kill you.</b> <b>Never use this appliance in an enclosed space.</b>
	

**WARNING:** Improper installation, adjustment, alteration, service or maintenance can cause injury or property damage. Read the installation, operating and maintenance instructions thoroughly before installing or servicing this equipment.

**WARNING:** For Outdoor Use Only.  
**Retain this manual for future reference.**

**AVERTISSEMENT:** Si les renseignements dans ce manuel ne sont pas suivies à la lettre, un incendie ou une explosion peut entraîner des dommages matériels, des blessures ou des pertes de vie.



**Pour votre sécurité**

Ne pas entreposer ni utiliser d'essence ou d'autres vapeurs et liquides inflammables à proximité de cet appareil ou de tout autre appareil.



**DANGER: S'il y a une odeur de gaz:**

- Coupez l'admission de gaz de l'appareil. Éteindre toute flamme nue. Si l'odeur persiste, éloignez-vous de l'appareil et appelez immédiatement le fournisseur de gaz ou le service d'incendie.

 <b>WARNING</b>	<b>MONOXYDE DE CARBONE</b>
	Cet appareil peut produire du monoxyde de carbone, un gaz inodore. L'utilisation de cet appareil dans des espaces clos peut entraîner la mort. Ne jamais utiliser cet appareil dans un espace clos.

**AVERTISSEMENT:** Une installation, un réglage, une modification ou entretien peut causer des blessures ou des dommages matériels. Lisez les instructions d'installation, d'exploitation et d'entretien avant d'installer ou de réparer ce matériel.

**AVERTISSEMENT:**

Pour usage extérieur seulement.

**Conservez ce manuel pour référence future.**

# Table of Contents

<b>INTRODUCTION</b> .....	
Specifications & Dimensions .....	4
Installation Codes.....	5
General Safety .....	5 - 6
<b>OPERATION</b> .....	
Lighting Instructions .....	7 - 9
Flame Adjustment .....	9
Gas Safety Information & Leak Testing.....	10
<b>INSTALLATION</b> .....	
Installation & Safety Notes .....	11
Unpacking .....	11
Minimum Clearances .....	11
Initial Firing, Manifold Pressure & Primary Air Adjustment .....	11
Altitude Adjustment .....	12
Field Assembled Parts .....	13
Rock & Glass Installation .....	13
<b>MAINTENANCE</b> .....	
Maintenance Safety .....	14
Recommended Service .....	14
Burner Cleaning .....	14
Trouble Shooting.....	15
Replacement Parts.....	16
Warranty .....	17 - 18
<b>LABEL INFORMATION</b> .....	18

**Inca Metal Cutting**  
**#100 – 11091 Bridgeport Road**  
**Richmond, BC V6X 1T3**  
**Canada**

---

# 1.0 INTRODUCTION

## 1.1 SPECIFICATIONS

TABLE 1

ITEM	NATURAL GAS	PROPANE (LPG)
INPUT: Hi	40,500 Btu/hr (11.87 kW)	32,500 Btu/hr (9.52 kW)
INPUT: Lo	29,000 Btu/hr (8.5 kW)	24,000 Btu/hr (7.03 kW)
GAS INLET SUPPLY PRESSURE:	Minimum: 5.0" w.c. (1.2 kPa)	Minimum: 12" w.c. (2.99 kPa)
	Maximum: 13.5" w.c. (3.4 kPa)	Maximum: 14" w.c. (3.49 kPa)
AIR SHUTTER SETTING	adjustable from 1/8" open to fully open	Fully open
ORIFICE SIZE: @ 0-2000'	# 30 DMS	# 47 DMS

### APPLIANCE DIMENSIONS

OD2000-45

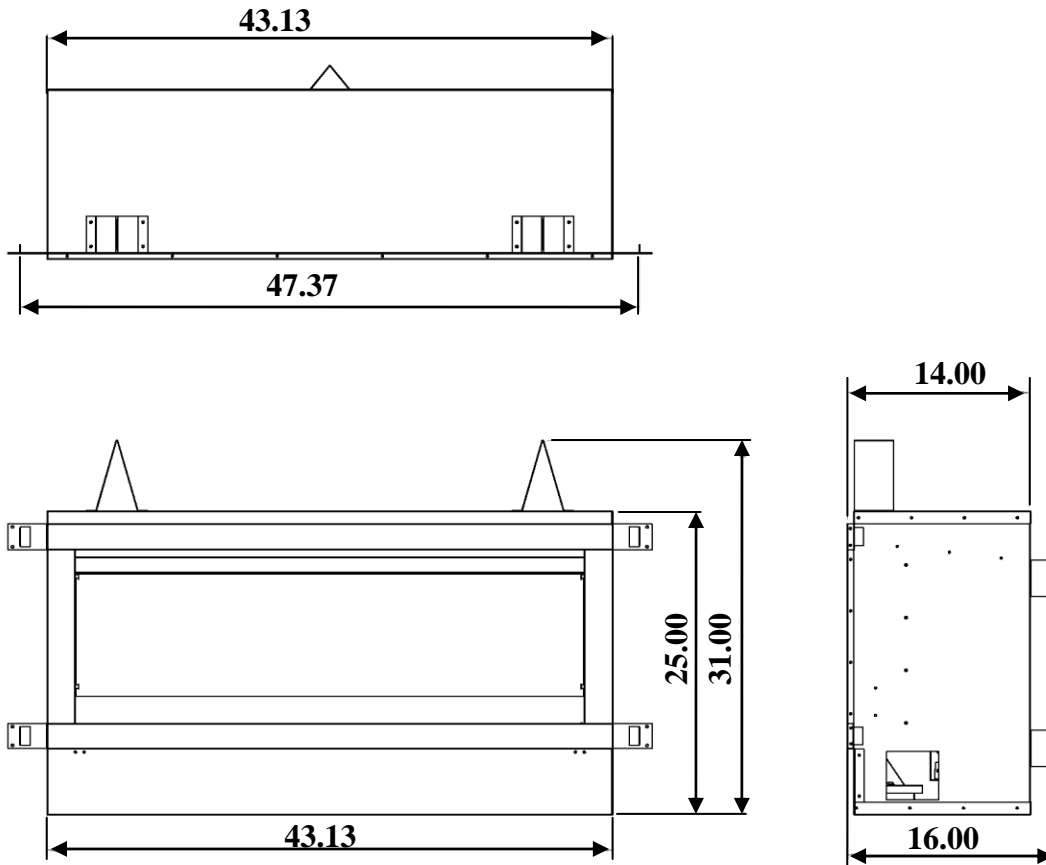

## INSTALLATION CODES

Installation must conform to local codes or in the absence of local codes, installation must conform to the *National Fuel Gas Code, ANSI Z233.1*, or the current *CAN/CGA B149.1 Installation Codes*. In the state of Massachusetts, this product can only be installed by a licensed plumber or a licensed gas fitter. Failure to comply will void the warranty.

### WARNING:

**DO NOT INSTALL THIS APPLIANCE WHERE THE FIREBOX, AND CONTROLS MAY COME IN CONTACT WITH DIRECT RAIN.**

**NE PAS INSTALLER CET APPAREIL OU LE FOYER, et contrôles peuvent Entrer en contact avec de la pluie.**

## GENERAL SAFETY

- Solid fuels shall not be burned in this fireplace. / Les combustibles solides doivent pas être brûlés dans ce foyer.
- Keep the appliance area clear and free from combustible materials, gasoline and other flammable vapors and liquids. / Maintenir la zone de l'appareil libre de matériaux combustibles, essence et autres vapeurs inflammables et des liquides.
- Inspect the burner prior to each use, if the burner is damaged it must be replaced prior to use. **NOTE:** Use only with burner part #1213. / Inspecter le brûleur avant chaque utilisation, si le brûleur est endommagé, il doit être remplacé avant l'utilisation. **REMARQUE:** Utilisez uniquement une partie du brûleur # 1213.
- Do not use this appliance if any part has been under water. Immediately call a qualified service technician to inspect the appliance and to replace any part of the control system and any gas control which has been under water. / Ne pas utiliser cet appareil si une partie quelconque a été submergée. Appelez immédiatement un technicien de service qualifié pour inspecter l'appareil et pour remplacer toute pièce du système de contrôle et toute commande de gaz qui a été sous l'eau.
- This fireplace is intended for installation on an outdoor patio or in your yard. It must never be installed inside the warm air envelope of your structure. / Cet appareil est conçu pour une installation sur une terrasse ou dans votre jardin. Il ne doit jamais être installé l'intérieur de l'enveloppe d'air chaud de votre structure

Children and adults should be alerted to the hazards of high surface temperature and should stay away to avoid burns or clothing ignition.

Young children should be carefully supervised when they are in the area of the appliance.

Clothing or other flammable material should not be hung from the appliance or placed near the appliance.

Any guard or other protective device removed for servicing the appliance must be replaced prior to operating the appliance.

Installation and repair should be done by a qualified service person. The appliance should be inspected before use and at least annually by a qualified service person. More frequent cleaning may be required as necessary. It is imperative that control compartments, burners and circulating air passageways of the appliance be kept clean.

Les enfants et les adultes doivent être sensibilisés aux dangers de la température de surface élevée et devraient rester à l'écart pour éviter les brûlures ou l'inflammation des vêtements.

Les jeunes enfants doivent être surveillés attentivement lorsqu'ils sont dans la zone de l'appareil.

Les vêtements et autres matériaux combustibles ne doivent pas être suspendus de l'appareil ou placés près de l'appareil.

Tout protecteur ou autre dispositif de protection retiré pour l'entretien doit être réinstallé avant d'utiliser l'appareil.

Installation et réparation doivent être effectuées par un technicien qualifié. L'appareil doit être inspecté avant son utilisation et au moins annuellement par une personne qualifiée. Un nettoyage plus fréquent peut être nécessaire si nécessaire. Il est impératif que les compartiments de contrôle, les brûleurs et les passages de circulation d'air de l'appareil restent propres.

- It is highly recommended that this fireplace be installed in a “sheltered” area. Direct wind will cause an erratic flame and possible pilot or main burner outage. / • Il est fortement recommandé que ce foyer est installé dans une zone "protégé". Vent direct provoquer une flamme irrégulière et pilote possible ou principal panne de brûleur.
- An erratic flame could also lead to excessive carboning (black soot), this condition is not a safety issue but is visually undesirable. / Une flamme erratique pourrait également entraîner des dépôts de carbone excessif (suie), cette condition n'est pas une question de sécurité mais est visuellement indésirable.
- Typical installation may include covered patio, screened porch, gazebo or an outside wall of a house. (If installing a propane fireplace the unit must be hard pipe connected.)  
Installation typique peut inclure terrasse couverte, véranda, gazebo ou un mur extérieur d'une maison. (Si l'installation d'un foyer au propane de l'unité doit être conduite dur connecté.)

**NOTE: Ensure the area has adequate ventilation**

**ATTENTION: S'assurer que la zone dispose d'une ventilation adéquate**

For appliances for use with a fixed fuel piping system and equipped with an appliance gas pressure regulator, the appliance and its individual shutoff valve must be disconnected from the gas supply piping system during any pressure testing of that system at test pressures in excess of ½ psi (3.5kPa)

The appliance must be isolated from the gas supply piping system by closing its individual manual shutoff valve during any pressure testing of the gas supply piping system at test pressures equal to or less than ½ psi (3.5 kPa).

## LIGHTING INSTRUCTIONS - for Intermittent Pilot

### FOR YOUR SAFETY, READ BEFORE LIGHTING

**WARNING: If you do not follow these instructions exactly, a fire or explosion may result causing property damage, personal injury or loss of life.**

- A. This appliance is equipped with an ignition device which automatically lights the pilot. Do not try to light the pilot by hand.
- B. BEFORE LIGHTING smell all around the appliance area for gas. Be sure to smell next to the floor because some gas is heavier than air and will settle on the floor.  
**WHAT TO DO IF YOU SMELL GAS**
  - Do not try to light any appliance.
  - Do not touch any electric switch; do not use any phone in your building.
  - Immediately call your gas supplier from a neighbour's phone. Follow the gas supplier's instructions.
  - If you cannot reach your gas supplier, call the fire department.
- C. Use only your hand to push in or turn the gas control knob. Never use tools. If the knob will not push in or turn by hand, don't try to repair it, call a qualified service technician. Force or attempted repair may result in a fire or explosion.
- D. Do not use this appliance if any part has been under water. Immediately call a qualified service technician to inspect the appliance and to replace any part of the control system and any gas control which has been under water.

### LIGHTING INSTRUCTIONS

1. **STOP!** Read the safety information above on this label.
2. Set the thermostat to the lowest setting.
3. Turn off all electric power to the appliance.
4. Do not attempt to light the pilot by hand.
5. Wait five (5) minutes to clear out any gas. Then smell for gas, including near the floor. If you smell gas, STOP! Follow "B" in the safety information above on this label. If you don't smell gas, go to the next step.
6. Turn on all electric power to the appliance.
7. Set thermostat to desired setting (or switch to "ON" if not using a thermostat).
8. If the appliance will not operate, follow the instructions "To Turn Off Gas To Appliance" and call your service technician or gas supplier.

### TO TURN GAS OFF TO APPLIANCE

1. Set thermostat to lowest setting.
2. Turn on/off switch to off.

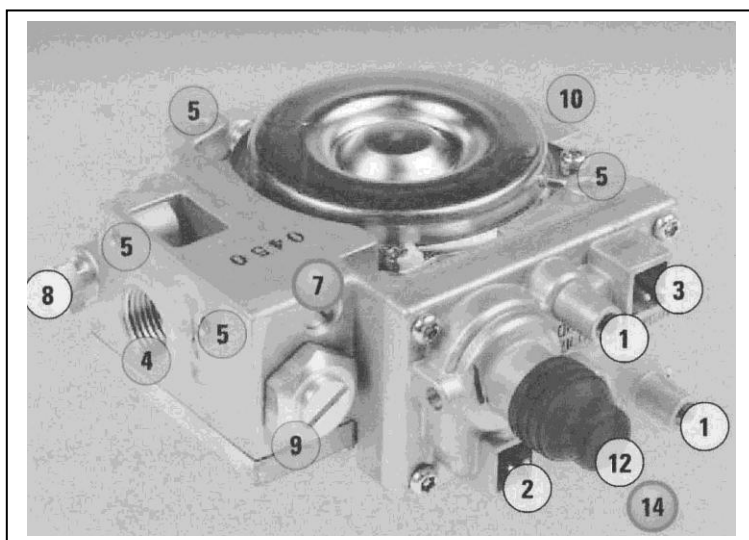

1. Pressure Taps
2. Main Valve Connection
3. Pilot Internal Solenoid Connection
4. Outlet Ports
5. Mounting Holes
7. Flow Control Screw
8. Pilot Connections
9. High/Low Connection
10. Inlet Ports

## 2.1 INSTRUCTIONS D'ALLUMAGE - Pilote intermittent

## POUR PLUS DE SÉCURITÉ, LIRE AVANT D'ALLUMER

**AVERTISSEMENT: Quiconque ne respecte pas à la lettre les instructions dans la présente notice risqué de déclencher un incendie ou une explosion entraînant des dommages, des blessures ou la mort.**

- A. Cet appareil est équipé d'un dispositif d'allumage qui allume automatiquement le pilote. Ne pas tenter d'allumer le pilote à la main.
- B. Avant d'allumer la veilleuse, reniflez tout autour de l'appareil pour déceler une odeur de gaz. Reniflez près du plancher, car certains gaz sont plus lourds que l'air et peuvent s'accumuler au niveau du sol.
- QUE FAIRE SI VOUS SENTEZ UNE ODEUR DE GAZ:**
- Ne pas tenter d'allumer d'appareil.
  - Ne touchez à aucun interrupteur; ne pas vous servir des téléphones se trouvant dans le bâtiment.
  - Appelez immédiatement votre fournisseur de gaz depuis un voisin. Suivez les instructions du fournisseur.
  - Si vous ne pouvez rejoindre le fournisseur, appelez le service des incendies.
- C. Ne pousser ou tourner la manette d'admission de gaz qu'à la main. Ne jamais employer d'outil à cette fin. Si la manette reste coincée, ne tentez pas de la réparer; appelez un technicien qualifié. Quiconque tente de forcer la manette ou de la réparer peut provoquer une explosion ou un incendie.
- D. N'utilisez pas cet appareil s'il a été plongé dans l'eau, même partiellement. Faites inspecter l'appareil par un technicien qualifié et remplacez toute partie du système de contrôle et toute commande qui ont été plongés dans l'eau.

## INSTRUCTIONS D'ALLUMAGE

1. **ARRÊTEZ!** Lisez les instructions de sécurité sur la portion supérieure de cette étiquette.
2. Réglez le thermostat à la température la plus basse.
3. Coupez l'alimentation électrique de l'appareil.
4. Ne tentez pas d'allumer le pilote à la main.
5. Attendez cinq (5) minutes\*\* pour laisser échapper tout le gaz. Reniflez tout autour de l'appareil, y compris près du plancher, pour déceler une odeur de gaz; Si vous sentez une odeur de gaz, ARRÊTEZ! Passez à l'étape B des instructions de sécurité sur la portion supérieure (à gauche) de cette étiquette. S'il n'y a pas d'odeur de gaz, passez à l'étape suivante.
7. Mettez l'appareil sous tension.
8. Réglez le thermostat à la température désirée.
9. Si l'appareil ne fonctionne pas, suivez les instructions "Pour couper le gaz à l'appareil" et appelez votre technicien ou votre fournisseur de gaz

## COMMENT COUPER L'ADMISSION DE GAZ L'APPAREIL

1. Réglez le thermostat à la température la plus basse
2. Activer / OFF sur OFF.

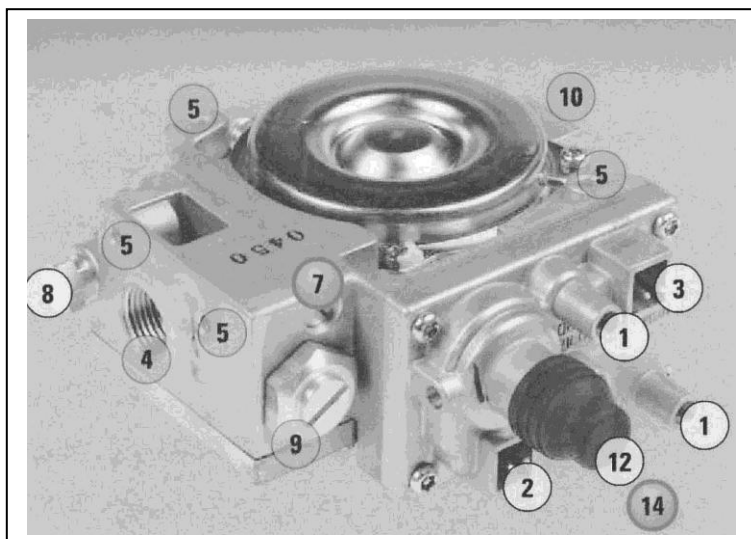

1. Prises de pression
2. Raccordement de la vanne principale
3. Pilote de connexion interne solénoïde
4. Ports de sortie
5. Trous de montage
7. Vis de réglage du débit
8. Connexions pilote
9. High/Low Connection
10. Ports d'entrée



# GAS VALVE DIAGRAM

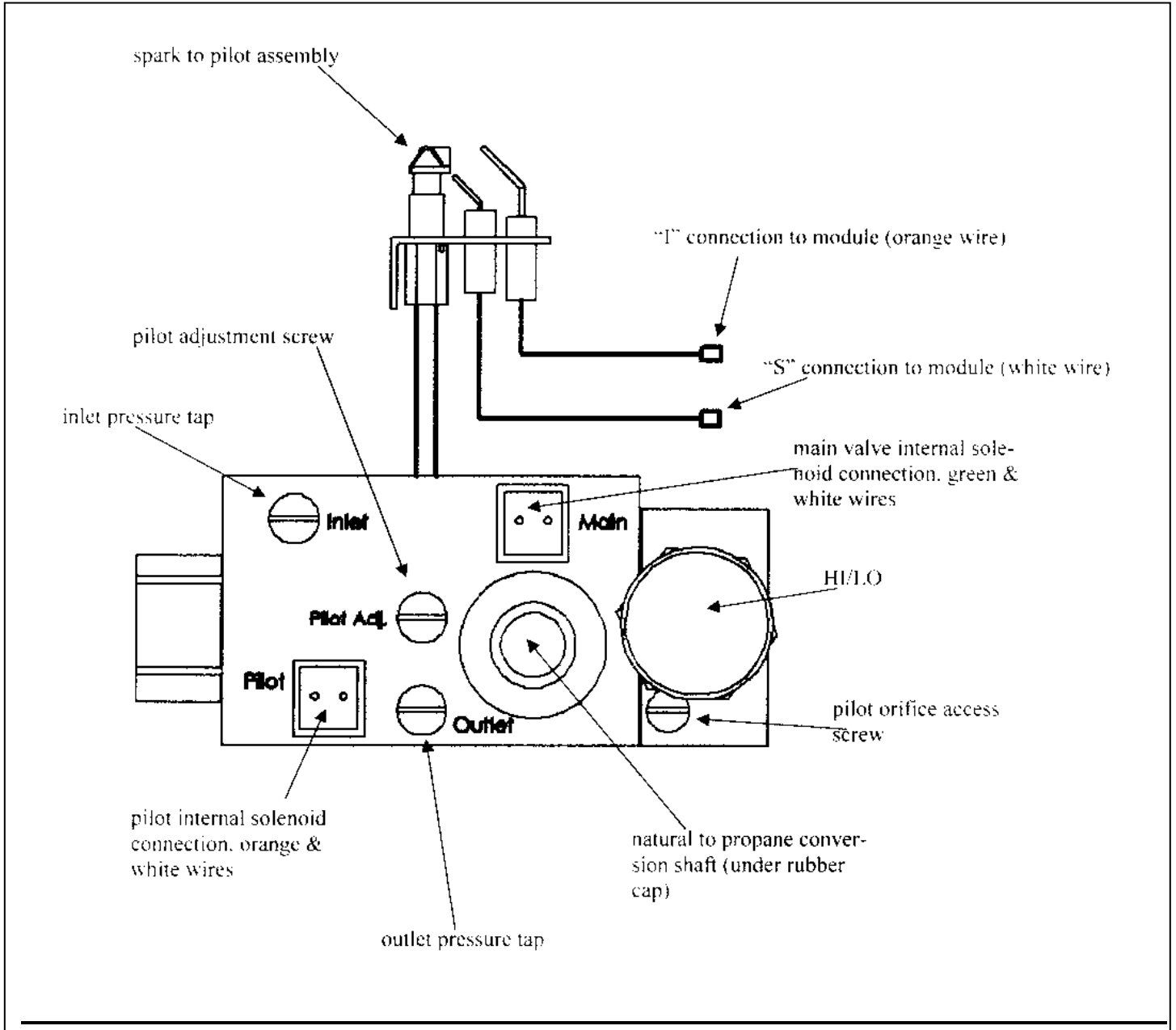

## FLAME ADJUSTMENT

The valve supplied with the appliance has a HI/LO knob to control the flame height. To adjust the flame height, turn the adjustment knob. Turning the knob in a clockwise direction sets the valve to the maximum setting, turning the knob in a counterclockwise direction sets the valve to the minimum setting.

## GAS SAFETY INFORMATION

### How to Leak Test Your Appliance

- Mix a solution of liquid soap and water in a small container.
- Make sure that the gas supply is turned on. For LP gas appliances make sure that the valve on the gas cylinder is turned on.
- Ensure that the gas control valve on the appliance is in the “OFF” position.
- Use a spray bottle or a small brush and liberally apply the solution to the gas line and to each connection.
- If there are bubbles forming this means that a leak is present.
- Tighten any connections that may be loose and leak test again.
- If no more leaks are found use the appliance, if leaks persist and cannot be stopped turn off the gas supply and contact your distributor or local gas service technician for assistance.
- **WARNING: Do not use an open flame to test for gas leaks.**

Leak testing with a small brush.



## INFORMATIONS SUR LA SÉCURITÉ I

### Comment fuites Testez vos appareils

- Mélanger une solution de savon liquide et de l'eau dans un petit récipient.
- Assurez-vous que l'alimentation en gaz est allumée. Pour les appareils à gaz LP s'assurer que la valve de la bouteille de gaz est allumée.
- Assurez-vous que la vanne de commande de gaz sur l'appareil est en position «OFF».
- Utilisez un vaporisateur ou une petite brosse et appliquez généreusement la solution à la conduite de gaz et à chaque connexion.
- S'il y a des bulles, cela signifie qu'une fuite est présente.
- Serrer tous les raccords qui peuvent être lâches et fuir de nouveau test.
- S'il n'y a plus les fuites sont trouvées utilisation de l'appareil, si les fuites persistent et ne peuvent pas être arrêtés éteindre l'alimentation en gaz et contactez votre distributeur ou un technicien de service de gaz local pour assistance.
- **ATTENTION: Ne pas utiliser de flamme nue pour détecter les fuites de gaz.**

**This unit is for permanent outdoor installation only and must be hard piped in with gas safety shut off, (regulator if required). Cannot be connected to an external propane bottle.**  
**Cet appareil est pour l'installation extérieure permanente et ne doit être dur d'ambiance avec la sécurité d'arrêt du gaz, (régulateur si nécessaire). Ne peut pas être relié à une bouteille de propane externe.**

# INSTALLATION & SAFETY NOTES

Read all instructions before starting installation and follow them carefully during installation to ensure maximum benefit and safety. Failure to follow these instructions will void your warranty and may present a fire hazard. See the warranty at the back of this manual for disclaimers regarding improper installation. This outdoor fireplace and its components are tested and safe when installed in accordance with this installation manual.

## UNPACKING

Please check the appliance carefully for any damaged or missing components. Report any problems to your dealer within 30 days of purchase.

## MINIMUM CLEARANCES

The minimum clearance to combustibles are as follows:

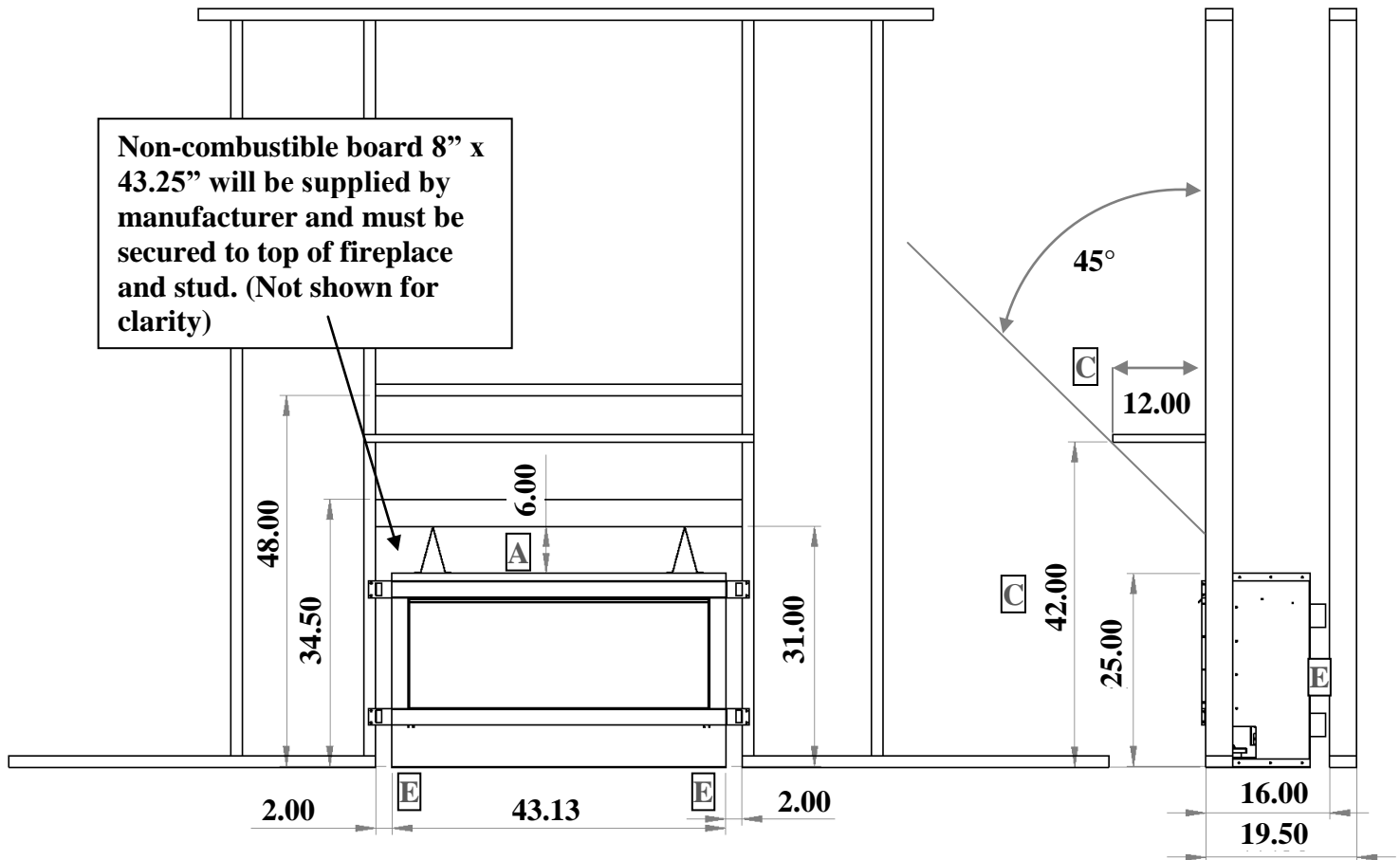

- A –Top 6" (152mm)
- B –Unit Trim to external sidewall 6" (152 mm) (NOT SHOWN)
- C - Mantle 42" (1067mm) high at 12" (305mm) horizontal
- D - Floor 0"
- E - Back & Sides 2"

**Note:** Check local codes for floor requirements. This fireplace is suitable for installation on a combustible surface. Non-combustible board will be supplied by manufacturer.

"Clearances are in accordance with local installation codes and the requirements of the gas supplier."

## INITIAL FIRING

When lit for the first time, the appliance may emit an odor resulting from evaporation of paint and lubricants used in the manufacturing process. This is normal and will subside after the unit has run for an hour or so. Periodic visual checks of the pilot and burner flames should be conducted. For proper operation, the pilot and main burner flames must be steady and not lifting off or floating. The top 3/8" – 1/2" (10-13mm) of the thermocouple should be engulfed by the pilot flame.

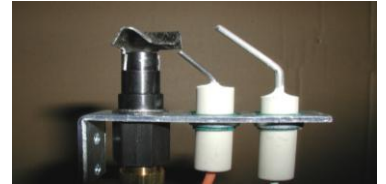

## MANIFOLD PRESSURE REGULATOR ADJUSTMENT

The manifold pressure regulator controls gas input and flame height, and is pre-adjusted at the factory. No further adjustment is required.

**Caution: Parts requiring adjustment during operation may be hot.**

## PRIMARY AIR ADJUSTMENT / AJUSTEMENT DE L'AIR PRIMAIRE

Aeration is factory set but may need adjustment for altitude or movement during shipping. / L'aération est réglée en usine, mais peut nécessiter un ajustement de l'altitude ou le mouvement pendant le transport.

To adjust the air shutter / Pour ajuster l'obturateur d'air

- 1/. Turn off the gas / Fermez le gaz
- 2/. Remove the door / Enlevez la porte
- 3/. Remove glass or logs from burner / Retirer le verre ou des billes de brûleur
- 4/. Remove the burner pan / Retirer la casserole du brûleur
- 5/. Undo the set screw on the air shutter and adjust accordingly then retighten the set screw. / Défaire la vis de réglage sur le volet d'air et d'ajuster en conséquence, puis resserrez la vis de réglage.

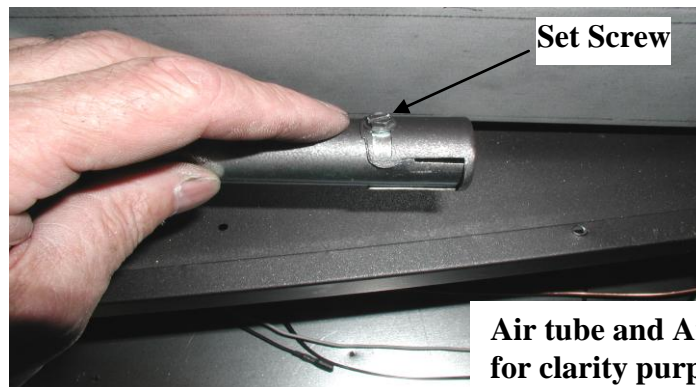

6/. Reassemble the fireplace in reverse order from 4 through 2. / Remonter la cheminée dans l'ordre inverse de 4 à 2.

7/. Turn on the gas. / Allumez le gaz.

**CAUTION  
ATTENTION**

**PARTS REQUIRING ADJUSTMENT DURING OPERATION MAY BE HOT.**

**PIECES NECESSITANT REGLAGE PENDANT LA MARCHE PEUT ETRE CHAUDE**

**Factory Setting**  
Natural Gas – open 1/8" (3.175mm)

## ALTITUDE ADJUSTMENT

All valves have been pre-set and certified for installation at elevations from 0 - 4000 feet (0 -1219.2m) above sea level.

When installing this unit at higher elevations, it is necessary to decrease the input rating by replacing the existing burner orifice with a smaller size for installations over 4000 feet (1219.2 m). The appliances input should be reduced 4% for each additional 1000 feet (305m) above sea level. For the USA, de-rate the unit from sea level according to the gas installation code.

## FIELD ASSEMBLED PARTS

Your outdoor fireplace comes fully assembled, to finish assembling the unit you must do the following:

1. Install rock and glass.
2. Connect the gas supply.

## ROCK & GLASS INSTALLATION / ROCK & VERRE D'INSTALLATION

Step 1.

Sprinkle burner channel with glass. Make sure to cover the burner pan evenly. Then add decorative rocks to outer pan area. / Saupoudrer le canal du brûleur avec verre. Assurez-vous de couvrir la casserole du brûleur de façon égale. Puis ajoutez les roches décoratives à la zone pan extérieur.



Step 2

Make sure that only the glass covers the burner holes. / Assurez-vous que seul le verre recouvre les trous du brûleur.

Turn your fireplace on and wait approximately 10-15 minutes until the flames are a nice yellow colour. Note the flame pattern and in any low or high areas adjust the amount of river glass to correct gas flow. / Transformez votre cheminée et attendez environ 10-15 minutes jusqu'à ce que les flammes sont une belle couleur jaune. Notez la forme de la flamme et dans tous les domaines à basse ou haute ajuster la quantité de verre rivière pour corriger débit de gaz.

**WARNING  
AVERTISSEMENT**

**YOU MUST WEAR FLAME AND HEAT RESISTANT GLOVES FOR THESE ADJUSTMENTS.**

**VOUS PORTER DES GANTS DE FLAMME ET RESISTANT A LA CHALEUR DE CES  
AJUSTEMENTS.**

## **MAINTENANCE**

---

### **MAINTENANCE SAFETY**

**Turn off the gas to the main burner and allow the fireplace to cool for 30 minutes before servicing.**

Service and repair should be done by a qualified service person. The appliance should be inspected before use and at least annually by a qualified service technician. It is important that the burner be kept clean to provide for adequate combustion and ventilation airflow. Do not substitute materials or use components other than factory supplied.

### **RECOMMENDED SERVICE**

Visually check the burner flame occasionally.

Have the appliance inspected annually by a professional service technician.

Clean the appliance regularly.

### **BURNER CLEANING**

Periodic cleaning is necessary for proper operation.

Remove the burner, and check that the burner orifice is clean.

Visually inspect the burner. Brush or blow away any dust, lint, or foreign debris. If the orifice is plugged, disassembly may be required to remove any foreign material from the orifice or tubing. For re-lighting, refer to the lighting instructions on page 7.

# TROUBLE SHOOTING - INTERMITTENT PILOT

SYMPTOM	POSSIBLE CAUSE	CORRECTIVE ACTION	
<b>I. Pilot will not light after repeated triggering of the remote control – intermittent pilot</b>	<b>A. No spark at electrode (weak or not heat source for pilot ignition)</b>		
	1. Improper ignition	1. Align the electrode with 1/8" (3mm) gap to pilot hood	
	2. Poor connections at starter and ignition electrode	2. Reconnect if loose	
	1. Broken ceramic cover on ignition electrode	3. Replace pilot assembly	
	2. Battery power low or dead	4. Replace batteries	
	<b>B. No gas or low gas pressure</b>		
	5. Gas line shut off(s) may not be turned on	5. Turn on shut-off valves	
	1. Air in gas lines	1. Purge gas lines	
	2. Gas lines may not be connected	2. Connect all gas lines	
	3. Low pressure may be caused by bent line	3. Check for a kinked line	
	<b>II. Pilot will not stay lit after following the lighting instructions</b>	<b>A. Thermocouple / Valve</b>	
		1. Weak or improperly located pilot flame	1. Adjust and clean pilot. The flame must impinge on or engulf the thermocouple, as shown in Figure 27.
		2. Defective thermocouple	2. Replace thermocouple
3. Thermocouple not installed properly		3. Make sure all wire connections at the gas valve terminals are tight and the thermocouple is fully inserted into the mounting bracket	
4. Open wire connection in pilot circuit		4. Check wire continuity and connections in the pilot circuit	
5. Defective Valve		5. Check with your voltmeter.	
<b>B. Defective safety circuit</b>			
1. Loose or defective connections		1. Check continuity, tighten wiring or connections, and repair	
<b>III. Main burner will not light</b>		<b>A. Valve / Switches</b>	
		1. Valve control off	1. Turn to "ON" position
	2. Blockage at the burner (line, orifice, or ports)	2. Check and clean	
	3. Defective remote	1. Conduct a continuity test or jumper wire test and replace if defective, check batteries	
	4. Defective wiring or connections	2. Conduct a test with a jumper wire and repair as required	
	5. Defective Valve	3. Contact service technician	
<b>I. Soot deposits</b>	1. Air inlet blocked or restricted	1. Clean air inlets	
	2. Incorrect media position	2. Make sure there is only glass coverage on the burner area.	

# **REPLACEMENT PARTS**

---

When requesting service or replacement parts for your unit, please provide model name and serial number. All parts listed below may be ordered from an authorized dealer.

<b><u>Description</u></b>	<b><u>Part#</u></b>
Burner	1213
Pilot Assembly	80869066
Orifice - NG	MP0505-30
Orifice - LPG	MP0505-47
Gas Valve	AF-4010
Valve Control Module	AF-4000MOD-1
Wire Harness	AF-40008PIN12WH2
Battery Back Up	AF-4000BBU
Valve Remote	1001-A
Front Cover	1233
Front Cover Pins	1127
Front Glass	1258
Front Louver	1222-A



# **INCA'S WARRANTY PROTECTION FOR ALL INCA GAS FIREPLACE PRODUCTS**

Inca's products are designed with superior components and materials, assembled by trained craftsmen who take great pride in their work. The burner and valve assembly are leak tested and test fired at a quality control test station. Once assembled the complete fireplace is thoroughly inspected by a qualified technician, before packaging, to ensure that you, the customer, receives the quality product that you expect from Inca's.

## **INCA'S GAS FIREPLACE'S WARRANTY**

Your Inca gas fireplace is guaranteed to be free of defects in materials and workmanship for a period of 5 years from the date of purchase.

Combustion chambers and wearable parts such as gas valves, wiring, igniter and gaskets are covered and Inca will provide replacement parts free of charge during the first year of the limited warranty

## **CONDITIONS AND LIMITATIONS**

Inca warrants its products against manufacturing defects to the original purchaser only – i.e. the individual or legal entity (registered customer) whose name appears on the original invoice – provided that the purchase was made through an authorized Inca dealer and is subject to the following conditions and limitations:

This factory warranty is nontransferable and may not be extended whatsoever by any of our representatives.

A licensed, authorized service technician or contractor must have installed the gas fireplace. Installation must be done in accordance with the installation instructions included with the product and all local and national building and fire codes.

This limited warranty does not cover damages caused by misuse, lack of maintenance, accident, alterations, abuse or neglect. Parts installed from other manufacturers will nullify this warranty.

This limited warranty further does not cover any scratches, dents, corrosion or discoloring caused by excessive heat, abrasives, chemical cleaners nor any venting components used in the installation of the fireplace.

Any installation, labor, construction, transportation or other related costs or expenses arising from defective part(s), repair or replacement or otherwise of same, will not be covered by this warranty nor shall Inca assume responsibility for same. Further, Inca will not be responsible for any incidental, indirect or consequent damages, except as provided by law, and in no event shall they exceed the original purchase price.

In the first year only, this warranty extends to the repair or replacement of warranted parts, which are defective in material or workmanship provided that the product has been operated in accordance with the operation instructions and under normal conditions.

After the first year, Inca may, at its discretion, fully discharge all obligations with respect to this warranty by refunding to the original warranted purchaser the wholesale price of any warranted but defective part(s).

## CONDITIONS AND LIMITATIONS (continued)

Notwithstanding any provisions contained in this warranty, Inca's responsibility under this warranty is defined as above and it shall not in any event extend to any incidental, consequential or indirect damages.

This warranty defines the obligations and liability of Inca with respect to the Inca gas fireplace and any other warranties expressed or implied with respect to this product, its components or accessories are excluded.

Inca neither assumes, nor authorizes any third party to assume, on its behalf, any other liabilities with respect to the sale of this product.

Any damages to fireplace, combustion chamber, or other component due to water, weather damage, long periods of dampness, condensation, damaging chemicals or cleaners will not be the responsibility of Inca.

The bill of sale or copy will be required together with a serial number and a model number when making any warranty claims from your authorized dealer.

Inca reserves the right to have its representative inspect any product or part thereof prior to honoring any warranty claim.

## LABEL INFORMATION

Inca Metal Cutting Ltd 100 - 11091 Bridgeport Rd Richmond, BC, V6X 1T3 Canada		<b>Outdoor LP Gas Fireplace</b> <b>OD2000-45</b>  Serial No.:
--	---	--

<b>CLIENT #</b> LC773211	<b>Model#</b>	NG Gas <input type="checkbox"/>	LP Gas <input type="checkbox"/>
<b>Certified To:</b> CSA 2.41-2014 and ANSI Z21.97-2014 Outdoor Decorative Gas Fireplace	Orifice Size	30	47
	Input Rating High btu/hr (kW)	40,500 (11.87)	32,500 (9.52)
	Input Rating Low btu/hr (kW)	29,000 (8.5)	24,000 (7.03)
	Manifold Pressure inches of water column (kPa)	1.7" - 3.5" (0.42—0.87)	6.4" - 10.0" (1.59—2.49)
	Max Inlet Supply inch w.c. (kPa)	13.5" (3.4)	14" (3.49)

 <b>DANGER</b>	<b>CARBON MONOXIDE HAZARD</b> This appliance can produce carbon monoxide which has no odor.  Using it in an enclosed space can kill you.  Never use this appliance in an enclosed space such as a camper, tent, car or home.
---	---

For Outdoor Use Only. / Pour usage à l'extérieur.

**WARNING:** Improper installation, adjustment, alteration, service or maintenance can cause injury or property damage. Refer to the owner's information manual provided with this appliance. For assistance or additional information consult a qualified installer, service agency or the gas supplier. / **AVERTISSEMENT:** Une installation, un réglage, une modification, un entretien ou peuvent causer des blessures ou des dommages matériels. Reportez-vous au manuel d'information du propriétaire fourni avec cet appareil. Pour de l'aide ou des renseignements supplémentaires, consultez un installateur qualifié, une agence de service ou le fournisseur de gaz.

**FOR YOUR SAFETY** Do not store or use gasoline or other flammable products, vapors or liquids in the vicinity of this or any other appliance. / **POUR VOTRE SECURITE** Ne pas entreposer ni utiliser d'essence ou d'autres produits inflammables, vapeurs ou liquides dans le voisinage de cet appareil ou de tout autre appareil.

**Cover must be removed when burner is in operation.** / **Housse doit être enlevé lorsque le brûleur est en fonctionnement.**

**Clearances to Combustibles. / Dégagements aux matériaux combustibles**  
 Sides: 2" (50.8mm). Back: 2" (50.8mm). Top: 6" (152mm). Exposed Sidewall: 6" (152mm).  
 Mantle: 12" (305mm) wide at 42" (1067mm) from floor. Floor: 0" (0mm)  
**For installation on combustible surfaces / Pour l'installation sur des surfaces combustibles**